

220 Kg/24h

Fabbricatori di ghiaccio modulare / Modular Ice Makers:
M145 F - M195 F - M205 F - M305 F - M405 F - M505 F
M145 - M195 - M205 - M305 - M405 - M505

M205 ALL GAS
230V/1N/50Hz
Modular Ice Makers



CARATTERISTICHE

- Scocca in acciaio
- Condensazione ad aria o acqua
- Ciclo di sanificazione
- Tasto comandi capacitivo
- Segnalazione acustica e luminosa allarmi
- Report allarmi HACCP
- Regolazione peso cubetto esterna
- Collegamento USB per aggiornamento sw e scarico dati HACCP
- Ventilatore condensatore controllato alle basse temperature ambiente
- Produzione ghiaccio programmabile
- Analisi predittiva malfunzionamenti
- Report prestazioni apparecchiatura.

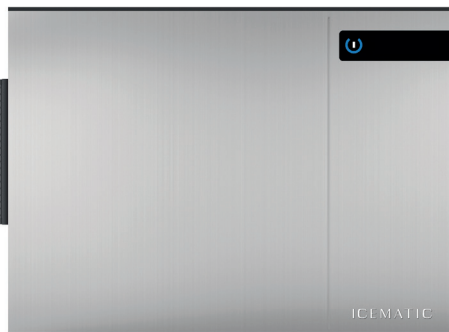

OPZIONALE

- Ciclo sanificazione programmabile con Ozono
- Trattamento nanotecnologico evaporatore con Rainbow technology
- Connessione cloud IOT
- Regolazione livello ghiaccio deposito

FEATURES

- Stainless steel construction
- Air or water condensation
- Sanitization cycle
- Capacitive button
- Acoustic and luminous alarms
- Report HACCP alarms
- External cube weight adjustment
- USB connection for software update and HACCP data download
- Condenser fan controlled at low ambient temperatures
- Programmable ice production
- Predictive analysis of malfunctions
- Machine performance report.

OPTIONAL

- Sanitization cycle programmable with Ozone
- Rainbow technology Nanotechnological evaporator treatment
- IOT cloud connection
- Storage bin ice level adjustment

DATI TECNICI - SPECIFICATIONS

		cond	comp. W	ABS. W	Fuse	Kwh/100Kg	I / h	kg	kg
M205 A AG	220-240/50/1		2834	1100	16	13.8	12.0	70	85
M205 W AG	220-240/50/1		2834	1000	16	11.6	105	70	85

TIPO GHIACCIO / ICE TYPE

	PCS / CYCLE	WEIGHT ICE
	PZ/CICLO	PESO GHIACCIO
HALF-LARGE 10X29X24 mm	370	6 g
DICE 22X22X24 mm	234	10 g
LARGE 29X29X24 mm	140	17 g

PRODUZIONE GHIACCIO / ICE PRODUCTION

kg/24h
lbs/24h

Raffreddamento ad Aria
Air Cooled Unit



Temp. Aria Air Temp.	Temp. Acqua / Water Temp.			
°C	32°	21°	15°	10°
°F	90°	70°	60°	50°
10°	172	200	214	220
50°	379	441	472	485
21°	163	186	200	205
70°	359	410	441	451
32°	131	150	155	160
90°	289	331	342	353
38°	116	129	133	136
100°	257	284	293	299

Raffreddamento ad Acqua
Water Cooled Unit



Temp. Aria Air Temp.	Temp. Acqua / Water Temp.			
°C	32°	21°	15°	10°
°F	90°	70°	60°	50°
10°	165	190	205	210
50°	364	419	452	463
21°	153	178	192	197
70°	337	392	423	434
32°	145	170	177	182
90°	320	375	390	401
38°	140	165	170	175
100°	309	364	375	386

Via del Lavoro, 9 31033 Castelfranco Veneto (TV) Tel.
+39 0423.738452 Fax +39 0423.722811
email: info@castelmac.it
www.castelmac.eu - www.icematic.eu

220 Kg/24h

Fabbricatori di ghiaccio modulare / Modular Ice Makers:
M145 F - M195 F - M205 F - M305 F - M405 F - M505 F
M145 - M195 - M205 - M305 - M405 - M505

M205 ALL GAS
230V/1N/50Hz
Modular Ice Makers

DIMENSIONI - DIMENSIONS

Vista frontale
Front view

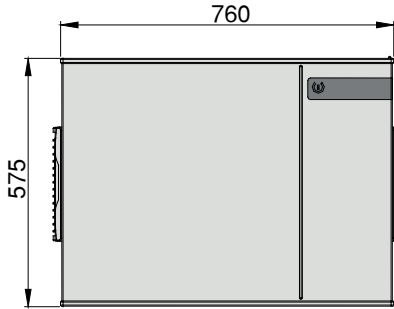

Vista laterale
Lateral view

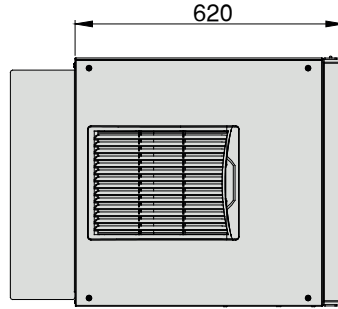

Vista superiore
Top view

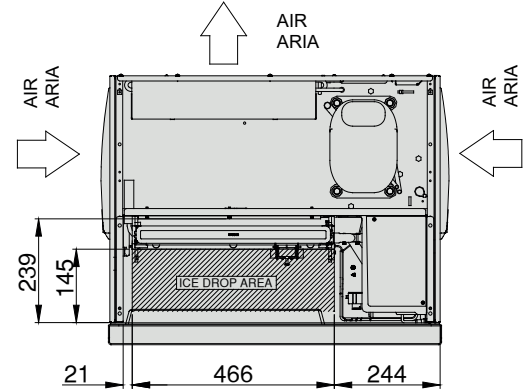

Raffreddato ad aria
Air cooled

Raffreddato ad acqua
Water cooled

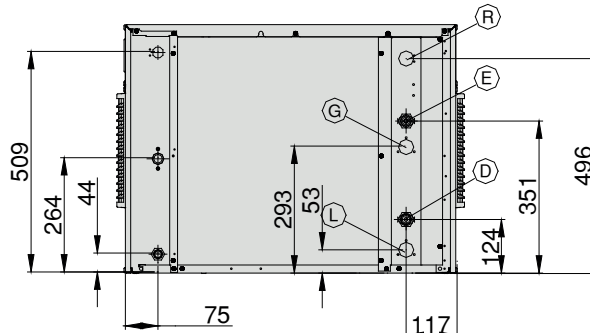
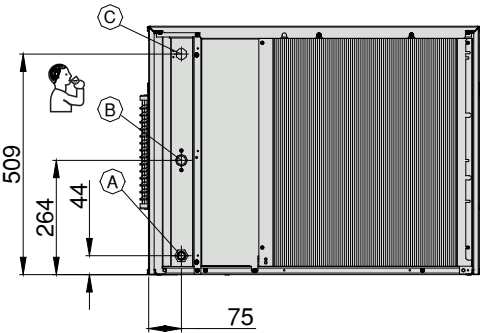

- A** Scarico acqua Ø 20mm
Water drain Ø 20mm
- B** Ingr. acqua potabile 3/4 GAS
Potable water inlet 3/4 GAS
- C** Ingresso alimentazione elettrica
Electrical cable supply

- D** Ingresso acqua cond. 3/4 GAS
Condenser water inlet 3/4 GAS
- E** Uscita acqua cond. 3/4 GAS
Condenser water outlet 3/4 GAS
- G** Mandata gas linea split 1/2"
connessione rapida maschio
Discharge gas split line 1/2"
male quick connection

- L** Aspirazione gas linea split 1/2"
connessione rapida maschio
Suction gas split line 1/2"
male quick connection
- R** Connessione alimentazione per
ventilatore condensatore remoto
Remote electrical connection
for condenser fans

TOUCH CONTROL

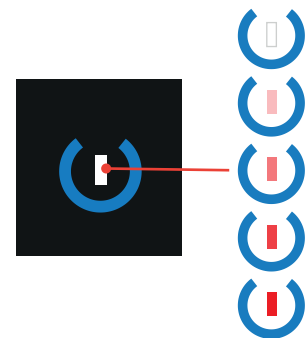

Capacitive Stand-by / Start button
(led continuous variation colors from white to red)

Tasto Capacitivo di Stand-by / Avvio
(led a variazione continua di colori dal bianco al rosso)

APP ALLGAS SYSTEM

Permette il comando e il monitoraggio dei produttori di ghiaccio direttamente da smartphone / It allows the control and monitoring of the ice machines directly from a smartphone

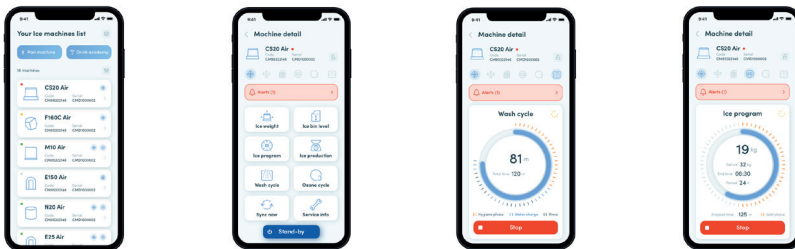

Condizioni operative - Operating requirements

	Min.	Max
Temp. Ambiente / Air Temperature	10°C	40°C
Temp. Acqua / Water Temperature	5°C	35°C
Press. Acqua / Water Pressure	1 Bar (14psi)	5 Bar (70psi)
Conducibilità acqua / Water conductivity	20 µS	500 µS
Alimentazione / Electrical supply	-10%	+10%

Calore espulso / Rejected Heat	2342 W
Volume Aria / Air Volume	590 m ³ /h

Via del Lavoro, 9 31033 Castelfranco Veneto (TV) Tel.
+39 0423.738452 Fax +39 0423.722811
email: info@castelmac.it
www.castelmac.eu - www.icematic.eu